

Colton, Ca (800) 949-9014
 San Diego, Ca (866) 271-4402
 Tracy, Ca (800) 366-1101



Sacramento, Ca (800) 375-6986
 Phoenix, AZ (800) 729-1473
 Las Vegas, NV (702) 649-1303

Your Heavy Equipment Wear Parts Specialists!

Blades

All O.E.M. Standard Cutting Edges and Wear Parts. Custom "Made to Order" Cutting Edges



Teeth

All O.E.M. Standard's as well as ESCO, Hensley, H & L, MTG, Proprietary



Tungsten Carbide

On all types of Cutting Edges * Segments * Teeth * Wear Plates



Shanks

Bolt on * Weld on (wrap around) & Loader or Back Hoe style (Flush mount)



Steel Plates

Hardox 450 & 550 * AR-400 & AR-500
 T-1 "A-514" * Grade 50 * CNC Flame Cutting
 Rolling * Forming



RIPPER SHANKS

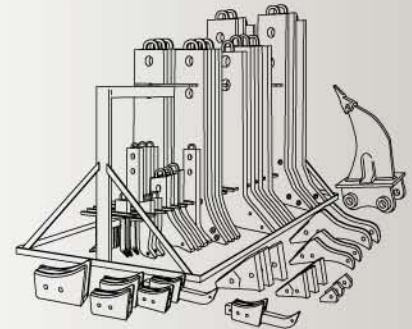

FABRICATION / MACHINE & REPAIR

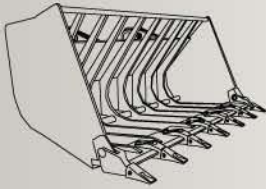

Custom Buckets



Bucket Repair & Fabrication



Single Shanks

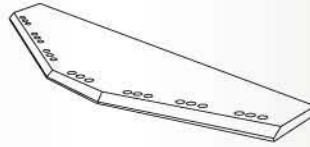

Bucket Moldboards

- *D4 - D11 single & multi-rippers in stock
- *Box Rippers for all sizes of backhoe and excavator buckets
- *Single Shank Rippers for large excavators
- *Scarifier Shanks
- *A full assortment of nose pieces, lower segments and guards

BLACK DIAMOND CRUSHING

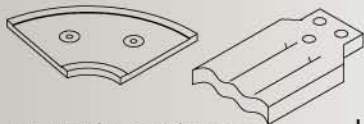

Ni-Hard & Hi-Chrome Augers & Paddles



Liners & Cheek Plates

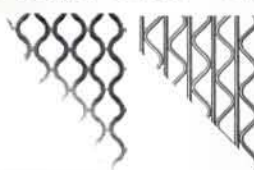

Screens

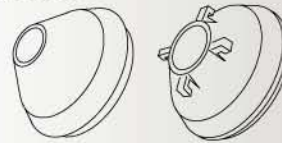

Cone Liners

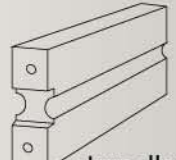

Impeller Bar

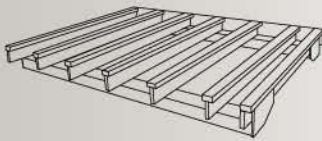

Grizzly Bars & Assemblies

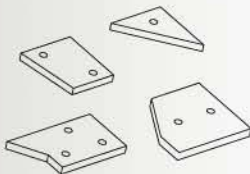

Jaw Liner

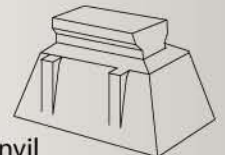

Anvil

Manganese and High Chrome Wear Parts for Crushers

WE PROUDLY REPRESENT



Scraper Floors, Inc.



**ALL SALES STAFF
 M.S.H.A. CERTIFIED**

Colton, Ca (800) 949-9014
 San Diego, Ca (866) 271-4402
 Tracy, Ca (800) 366-1101



Sacramento, Ca (800) 375-6986
 Phoenix, AZ (800) 729-1473
 Las Vegas, NV (702) 649-1303

**ALL SALES STAFF
 M.S.H.A. CERTIFIED**



SCRAPER PARTS

Ejector Skins

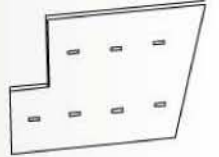
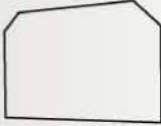

Side Skins

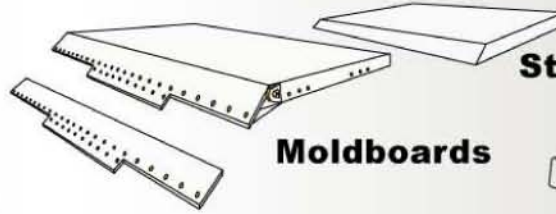

Moldboards

Moving & Stationary Floors



Rear Ejector Channels



Formed Bumper Channels

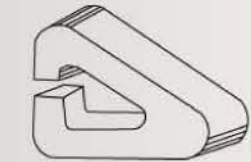
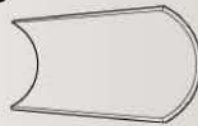

Floor Locks

Stinger Plates

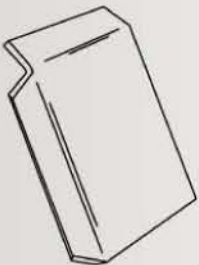
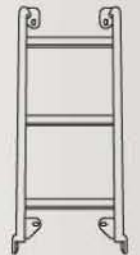

Push Plates



Floor Guides

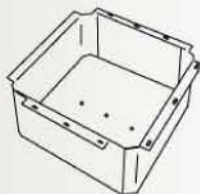

Battery Boxes

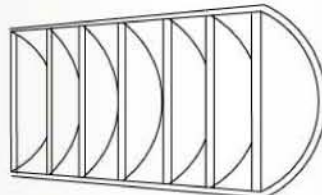

Stinger Plate Assemblies



Moving Floor Rails

Side Ejector Rails

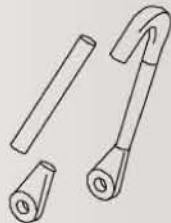

Bail Repair Tubing

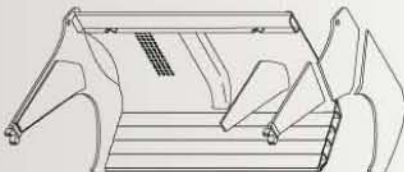

Aprons, Apron Kits, Apron Arms 1/4, 1/2 & Full

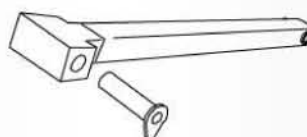

Floor Links / Link Pins



Floor Hanger Brackets / Hanger Rollers

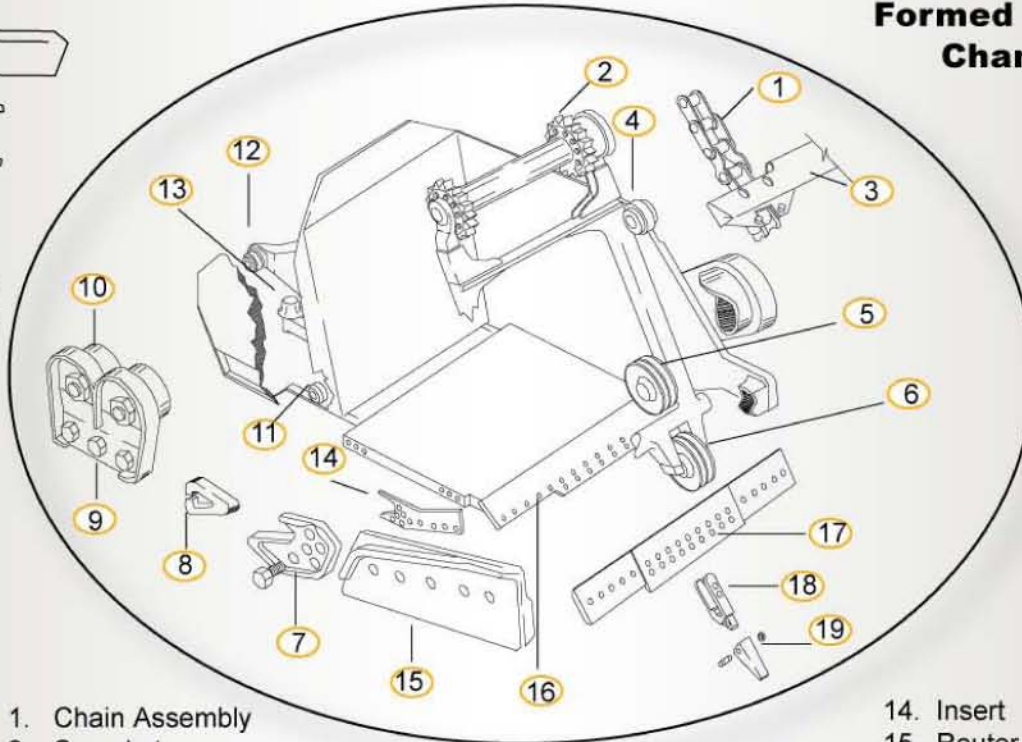

- 1. Chain Assembly
- 2. Sprocket
- 3. Flight
- 4. Upper Chain Roller Assembly
- 5. Center Idler Assembly
- 6. Bottom Idler Assembly
- 7. Floor Guide
- 8. Lock
- 9. Bracket-Roller Hanger
- 10, 11, 12 & 13 Roller
- 14. Insert
- 15. Router Bit
- 16. Moldboard
- 17. Blades
- 18. Adapter
- 19. Tooth

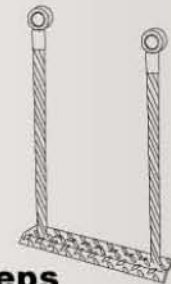

Steps